

# MJTP SERIES 6MM & 4MM SMD TACT SWITCHES

## FEATURES

- Numerous single pole-single throw momentary configurations.
- Excellent tactile feed-back (Snap dome).
- Ultra-compact size.
- Long operating life for high reliability.
- Molded-in terminals minimize wicking of flux or solder.

## MATERIALS

Case: High temperature 4/6 nylon.  
 Actuator: High temperature 4/6 nylon.  
 Cover/Bracket: PET film, tin plated brass or stainless steel.  
 Terminals: Silver plated brass.  
 Shorting Contact: Phosphor bronze or stainless steel with silver plating.  
 L.E.D. rating: Forward voltage- 2.1 V (3.0 V Max.). Cont. fwd. current 20mA max. @ 25°C.

Gold plating available on contacts & terminals  
 - consult factory.

## GENERAL SPECIFICATIONS

### ELECTRICALS

Contact rating: 50 mA @ 12 VDC  
 Insulation resistance: 100 megohms min. (100 VDC)  
 Dielectric withstanding voltage: 250 VAC for 1 minute  
 Contact resistance: 100 milliohms max. @ 5 VDC, 10 mA  
 Electrical life: 100,000 cycles min. (1,000,000 cycles available - consult factory)  
 Contact bounce: less than 10 msec.

### MECHANICALS, THERMALS, ENVIRONMENTALS

Plunger travel: .010" + .008", - .004" (0,25 +0,2, -0,1 mm)  
 Actuation force: 160 grams ±30 grams  
 Operating temperature range: -20°C to +70°C  
 Storage temperature range: -30°C to +80°C for 96 hours  
 Shock resistance: 30G per method 213, MIL-STD-202  
 Vibration resistance: passes method 201, MIL-STD-202

### SOLDERING (note - non-washable except for models indicated as 'process compatible').

IR reflow soldering: 240°C max. for 20 seconds max.  
 Wave soldering: 255°C max. for 5 seconds max.  
 Hand soldering: 320°C max. for 3.5 seconds max. (40 watt iron max.)

SPECIFICATIONS SUBJECT TO CHANGE WITHOUT NOTICE.

### US # MJTP1106S

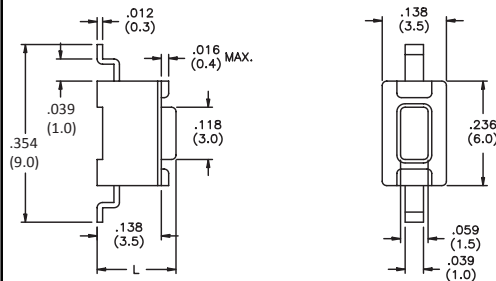

US Model No.	Dim. L (in./mm)
<b>MJTP1106S</b>	.169 (4,3)
<b>MJTP1106SA</b>	.197 (5,0)

Bulk packaged.

### US # MJTP1106SATR

Same as above, except supplied on tape and reel as shown.

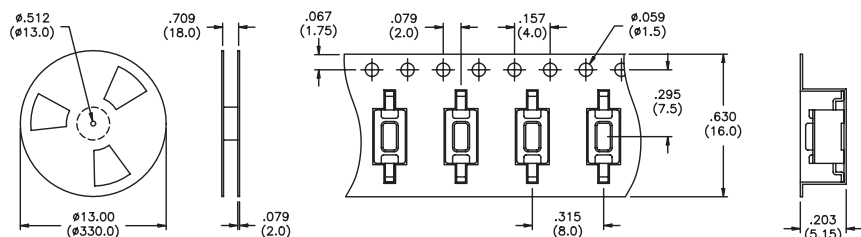

Tape & reel packaging - quantity 1800 per reel.

**US # MJTP1122**  
Grounding

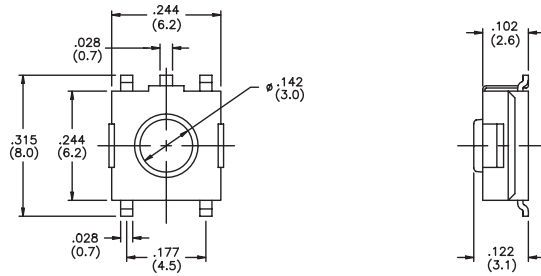

Bulk packaged.

**US # MJTP1122A**  
Grounding

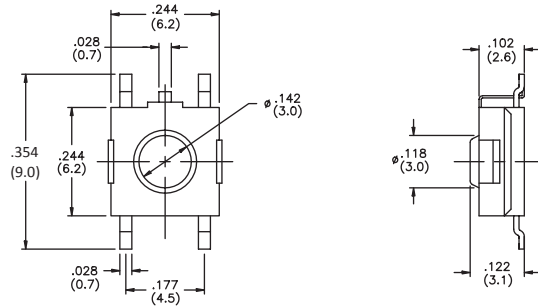

Bulk packaged.

**US # MJTP1122B**  
**EU # PHAP3374**

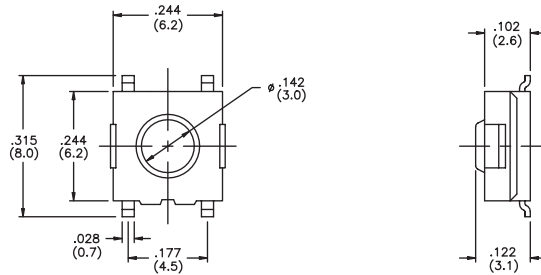

Bulk packaged.

**US # MJTP1122TR,**  
**MJTP1122BTR &**  
**MJTP3374TR**  
**EU # PHAP3374R**

Same as above,  
except supplied  
on tape & reel  
as shown.  
Note -  
MJTP1122A  
not available on  
tape & reel.

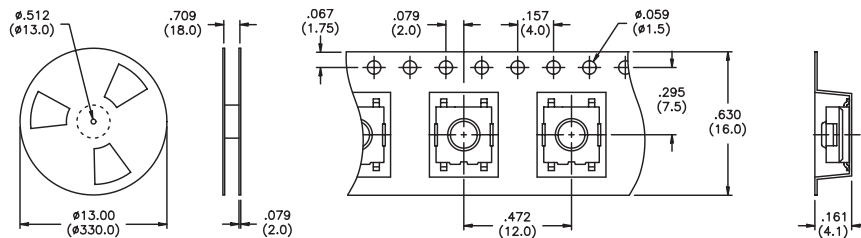

Tape & reel packaging - quantity 1500 per reel.

SPECIFICATIONS SUBJECT TO CHANGE WITHOUT NOTICE.

SPECIFICATIONS SUBJECT TO CHANGE WITHOUT NOTICE.

**US # MJTP1125B**

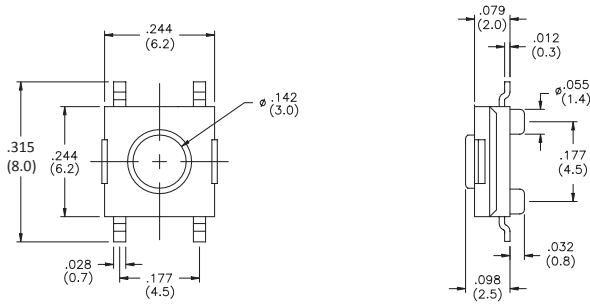

Bulk packaged.

**US # MJTP1138  
EU # PHAP3368**

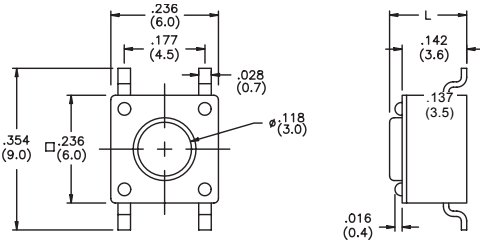

US Model No.	Dim. L (in./mm)	EU Model No.
<b>MJTP1138</b>	.170 (4,3)	<b>PHAP3368</b>
<b>MJTP1138A</b>	.197 (5,0)	<b>PHAP3368A</b>
<b>MJTP1138B</b>	.374 (9,5)	<b>PHAP3368B</b>
<b>MJTP1138C</b>	.315 (8,0)	<b>PHAP3368C</b>
<b>MJTP1138D</b>	.512 (13,0)	<b>PHAP3368D</b>
<b>MJTP1138E</b>	.287 (7,3)	<b>PHAP3368E</b>
<b>MJTP1138F</b>	.335 (8,5)	<b>PHAP3368F</b>
<b>MJTP1138G</b>	.275 (7,0)	N/A

Bulk packaged. Tubes available for some models consult factory.

**US # MJTP1138TR**

Same as above except supplied on tape & reel as shown.

Tape & reel:  
 MJTP1138ATR = 500 pcs.  
 MJTP1138BTR = 500 pcs  
 MJTP1138CTR = 700 pcs  
 MJTP1138ETR = 750 pcs  
 MJTP1138FTR = 700 pcs  
 MJTP1138GTR = 750 pcs

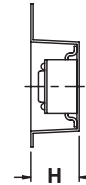
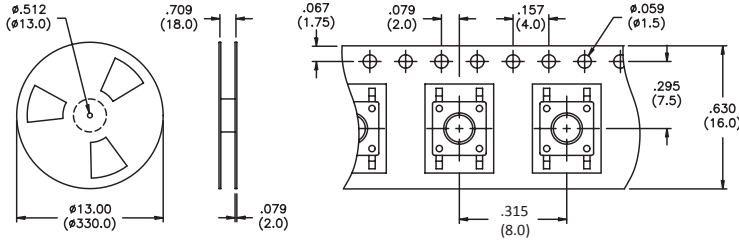

Part #	H
MJTP1138-	.213 (5.4)
MJTP1138A	.213 (5.4)
MJTP1138B	.394 (10.0)
MJTP1138C	.343 (8.7)
MJTP1138E	.299 (7.6)
MJTP1138F	.343 (8.7)
MJTP1138G	.299 (7.6)

MJTP1138TR & MJTP1138ATR: Tape & reel packaging - quantity 1200 pcs

**US # MJTP1140**  
**EU # PHAP3390**  
 4mm x 4mm

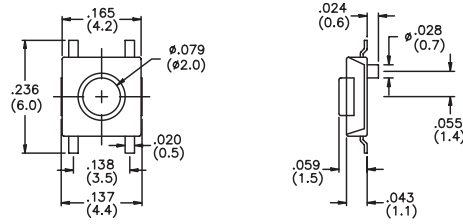

Bulk packaged.

**US # MJTP1140A**  
**EU # PHAP3391**

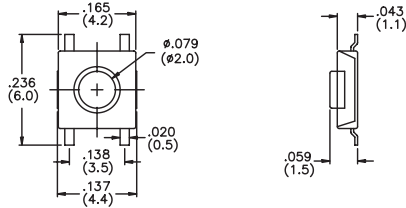

Bulk packaged.

**US # MJTP1140TR & MJTP1140ATR**  
**EU # PHAP3390R & PHAP3391R**

Same as above, except supplied on tape & reel as shown.

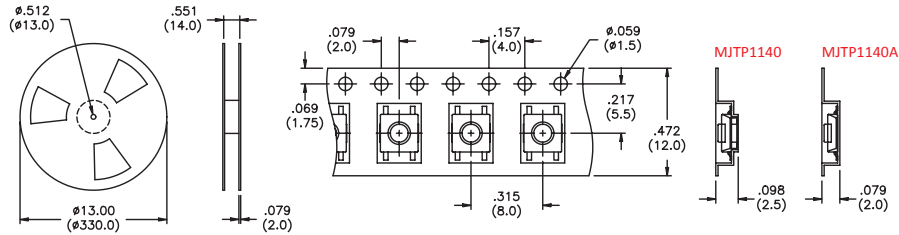

Tape & reel packaging - quantity 3400 per reel.

**US # MJTP1162**  
**EU # PHAP3371**

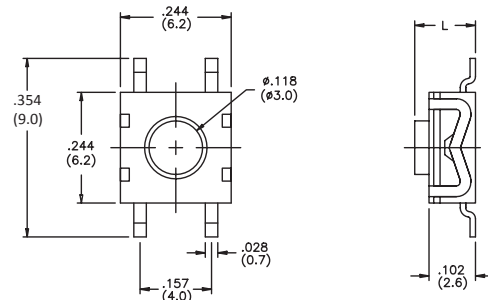

US Model No.	Dim. L (in./mm)	EU Model No.
MJTP1162	.102 (2,6)	PHAP3371
MJTP1162A	.134 (3,4)	PHAP3371A

Bulk packaged.

SPECIFICATIONS SUBJECT TO CHANGE WITHOUT NOTICE.

SPECIFICATIONS SUBJECT TO CHANGE WITHOUT NOTICE.

**US # MJTP1162TR & MJTP1162ATR**  
**EU # PHAP3371R & PHAP3371AR**  
 Same as above except supplied on tape & reel as shown.

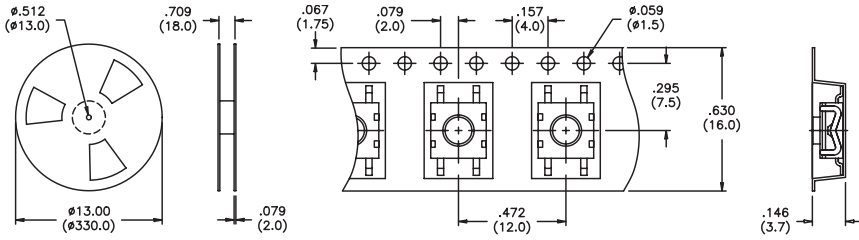

Tape & reel packaging - quantity 1600 per reel.

**US # MJTPSJW66N**  
 Process compatible

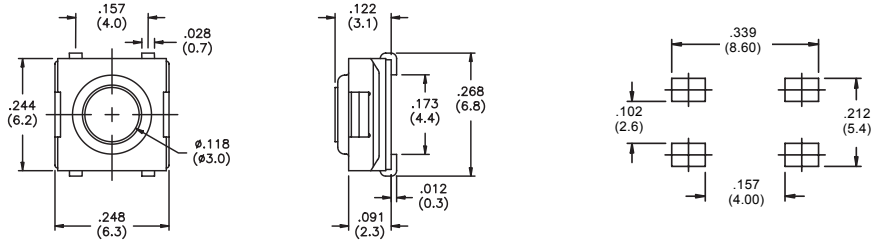

Bulk packaged.

**US # MJTPSJW69N**  
 Process compatible

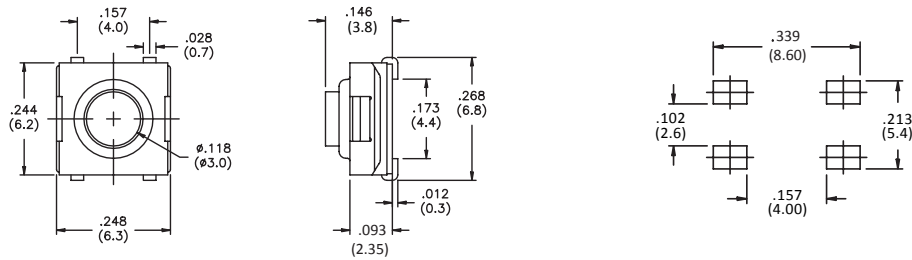

Bulk packaged.

**US # MJTPSMW**  
 Process compatible

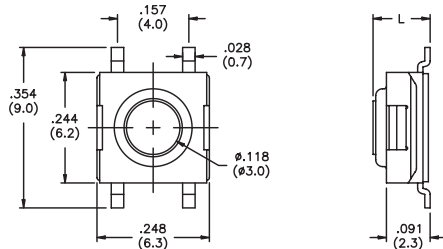

US Model No.	Dim. L (in./mm)
<b>MJTPSMW</b>	.122 (3,1)
<b>MJTPSMWA</b>	.091 (2,3)
<b>MJTPSMWB</b>	.146 (3,8)

Bulk packaged.

**US # MJTPSMWTR & MJTPSMWATR, MJTPSMWBTR**  
 Same as above except supplied on tape & reel as shown.

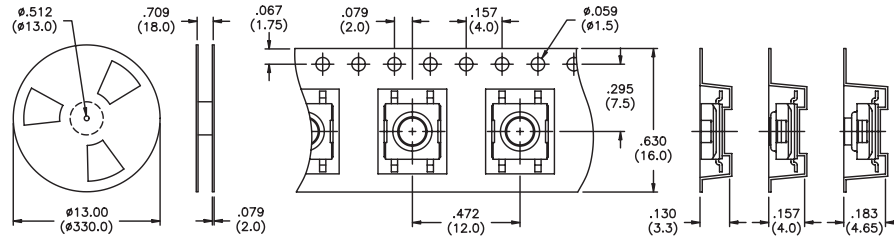

Tape & reel packaging - quantity 'MWTR' & 'MWATR' 2000 per reel, 'MWBTR' 1900 per reel.

**SCHEMATICS**

MJTP1122  
 MJTP1125  
 MJTP1137  
 MJTP1138  
 MJTP1140  
 MJTP1162  
 MJTPSJW66N  
 MJTPSJW69N  
 MJTPSMW

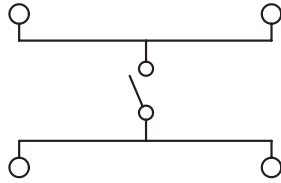

MJTP1106

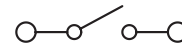

**PRINTED CIRCUIT BOARD LAYOUTS**

Layout tolerances; Linear:  $\pm .004"$  ( $\pm 0,1MM$ ) Holes:  $\pm .002"$  ( $\pm 0,05MM$ ) Pads:  $\pm .008"$  ( $\pm 0,2MM$ )

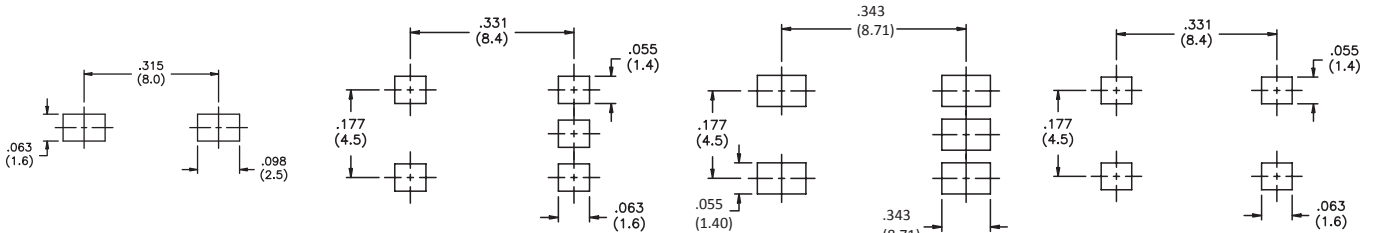

MJTP1106S

MJTP1122

MJTP1122A

MJTP1122B

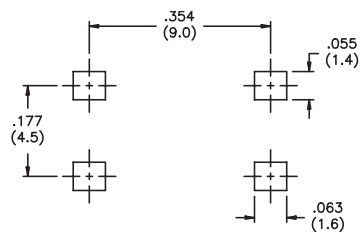

MJTP1138

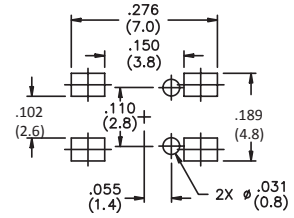

MJTP1140

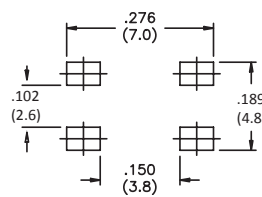

MJTP1140A

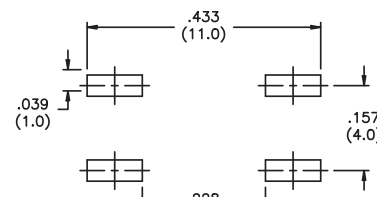

MJTP1162

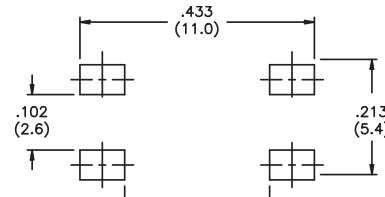

MJTPSMW

SPECIFICATIONS SUBJECT TO CHANGE WITHOUT NOTICE. UC1506US